

# MIRELA 150

# MIRELA 160

150 x 75 x 43 cm, 150 l

160 x 75 x 43 cm, 160 l

**polysan** 

POLYSAN, s.r.o. - Nesměřice 52, Zruč nad Sázavou, CZ-285 22, Czech Republic

e-mail : info@polysan.net

www.polysan.net

	kód	CZK bez DPH	CZK s DPH	kód	CZK bez DPH	CZK s DPH
<b>vany (bílé)</b>						
		vana s podstavcem			vana s konstrukcí	
<b>MIRELA 150</b>	<b>45111</b>	<b>5 874,-</b>	6 990,-	<b>45211</b>	<b>8 529,-</b>	10 150,-
<b>MIRELA 160</b>	<b>40111</b>	<b>6 160,-</b>	7 330,-	<b>40211</b>	<b>8 815,-</b>	10 490,-

obkladové panely (bílé 590 mm)			kód	CZK bez DPH	CZK s DPH
<b>U-panel MIRELA 150</b>	čelní	ABS/PMMA	<b>45317</b>	<b>2 487,-</b>	2 960,-
<b>U-panel MIRELA 150</b>	boční	ABS/PMMA	<b>45316</b>	<b>1 227,-</b>	1 460,-
<b>NIKA-panel MIRELA 150</b>	čelní	ABS/PMMA	<b>45318</b>	<b>2 487,-</b>	2 960,-
<b>ULN-panel MIRELA 150</b>	čelní	ABS/PMMA	<b>45322</b>	<b>2 685,-</b>	3 195,-
<b>UL-panel MIRELA 150</b>	rohový	ABS/PMMA	<b>45311</b>	<b>4 025,-</b>	4 790,-
<b>U-panel MIRELA 160</b>	čelní	ABS/PMMA	<b>40317</b>	<b>2 487,-</b>	2 960,-
<b>U-panel MIRELA 160</b>	boční	ABS/PMMA	<b>40316</b>	<b>1 227,-</b>	1 460,-
<b>NIKA-panel MIRELA 160</b>	čelní	ABS/PMMA	<b>40318</b>	<b>2 487,-</b>	2 960,-
<b>ULN-panel MIRELA 160</b>	čelní	ABS/PMMA	<b>40322</b>	<b>2 685,-</b>	3 195,-
<b>UL-panel MIRELA 160</b>	rohový	ABS/PMMA	<b>40311</b>	<b>4 025,-</b>	4 790,-

ABS/PMMA = ABS panel s povrchem z polymethylmetakrylátu (nevzdušený panel)



**S 475 PO 60**

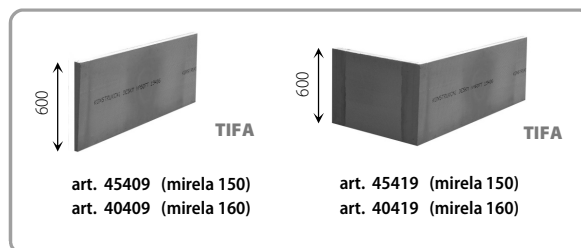

## příplatky pro panely a vany

manhattan, pergamon, ägäis	příplatek za barvu - vana	<b>30%</b>
ostatní barvy	příplatek za barvu - vana	<b>45%</b>
vzdušení bílého panelu nástřikem (stříkaný ABS panel)		<b>100%</b>
příplatek za barevný panel (stříkaný PMMA panel)		<b>100%</b>

podhlavníky		kód	CZK bez DPH	CZK s DPH
<b>STAR</b>	<b>bílý</b>	<b>250070</b>	<b>484,-</b>	576,-
<b>STAR</b>	<b>černý</b>	<b>250071</b>	<b>484,-</b>	576,-
<b>STAR</b>	<b>stříbrný</b>	<b>250072</b>	<b>484,-</b>	576,-
madla		kód	CZK bez DPH	CZK s DPH
<b>madlo MIRELA (pár)</b>	<b>nerez</b>	<b>40414</b>	<b>2 198,-</b>	2 616,-
<b>madlo MIRELA (pár)</b>	<b>zelené</b>	<b>40415</b>	<b>2 442,-</b>	2 906,-
<b>madlo MIRELA (pár)</b>	<b>stříbrné</b>	<b>40416</b>	<b>3 174,-</b>	3 777,-

Další informace k madlům a podhlavníkům POLYSAN - viz str. 64

panely TIFA			kód	CZK bez DPH	CZK s DPH
<b>TIFA panel MIRELA 150</b>	čelní	TIFA	<b>45409</b>	<b>2 100,-</b>	2 499,-
<b>TIFA panel MIRELA 150</b>	rohový	TIFA	<b>45419</b>	<b>3 328,-</b>	3 960,-
<b>TIFA panel MIRELA 160</b>	čelní	TIFA	<b>40409</b>	<b>2 100,-</b>	2 499,-
<b>TIFA panel MIRELA 160</b>	rohový	TIFA	<b>40419</b>	<b>3 328,-</b>	3 960,-

zástěny		kód	CZK bez DPH	CZK s DPH
<b>LANKA 3</b>	<b>bílá</b>	<b>35117</b>	<b>9 861,-</b>	11 735,-
<b>OLBIA</b>	<b>bílá</b>	<b>30117</b>	<b>10 213,-</b>	12 153,-
<b>OLBIA</b>	<b>stříbrná</b>	<b>30317</b>	<b>11 129,-</b>	13 244,-
<b>VENUS 2</b>	<b>bílá</b>	<b>36127</b>	<b>8 445,-</b>	10 050,-

Další informace k pneumatickým zástěnám POLYSAN - viz str. 62 - 63

## hydromasážní systémy – typ A

	kód	CZK bez DPH	CZK s DPH
<b>MIDI PLUS</b> (provedení trysek chrom nebo bílá)	<b>MPA</b>	<b>27 100,-</b>	32 249,-
<b>TURBOAIR</b> (provedení trysek chrom nebo bílá)	<b>TBA</b>	<b>23 100,-</b>	27 489,-

	kód	CZK bez DPH	CZK s DPH
<b>TURBOAIR KOMBI</b> (provedení trysek chrom nebo bílá)	<b>TKA</b>	<b>29 100,-</b>	34 629,-
<b>MAXIMUM</b> (provedení trysek chrom nebo bílá)	<b>MXA</b>	<b>44 450,-</b>	52 896,-

Cena HM systému zahrnuje cenu vanové konstrukce, ovládání typu A, vanové soupravy a cenu montáže HM systému (k této ceně nutno přičíst cenu vany s podstavcem - není v ceně).

Podrobné informace o všech HM systémech Polysan, včetně variant typu B a P jsou uvedeny na stránkách 66 - 67.

Příplatek za provedení se zlatými tryskami: příplatek 30% k ceně za provedení typu A

Jednotlivá provedení van a systémů jsou vyobrazeny také na stránkách [www.polysan.cz](http://www.polysan.cz) a [www.polysan.net](http://www.polysan.net).

Všechny ceny jsou uvedeny bez dopravy.

# MIRELA 150 MIRELA 160

150 x 75 x 43 cm

150I

160 x 75 x 43 cm









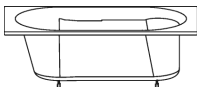
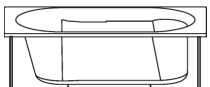

160I

**polysan** 

POLYSAN, s.r.o. - Nesměřice 52, Zruč nad Sázavou, CZ-285 22, Czech Republic

e-mail : info@polysan.net

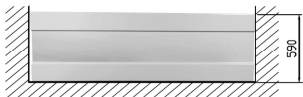
www.polysan.net

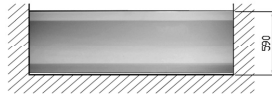
						
art. 45111 (mirela 150) art. 40111 (mirela 160)	art. 45211 (mirela 150) art. 40211 (mirela 160)	star art. 250070 - 250072	art. 40414 (nerez) art. 40415 (bílé) art. 40416 (zlaté)	venus 2 art. 36127	lanka 3 art. 35117	olbia art. 30117 ○ art. 30317 ○
						
U - boční art. 45316 (mirela 150) art. 40316 (mirela 160)	U - želni art. 45317 (mirela 150) art. 40317 (mirela 160)	NIKA art. 45318 (mirela 150) art. 40318 (mirela 160)	UL art. 45311 (mirela 150) art. 40311 (mirela 160)	ULN art. 45322 (mirela 150) art. 40322 (mirela 160)		

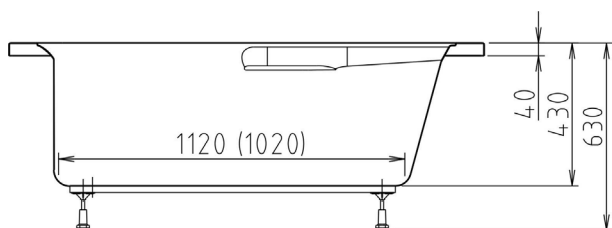

V případě použití TIFA panelu je třeba brát v úvahu při instalaci vany jeho vyšší výšku (60 cm).  
Rozměry v nákresu uvádějí doporučenou výšku vany při použití akrylátového panelu.

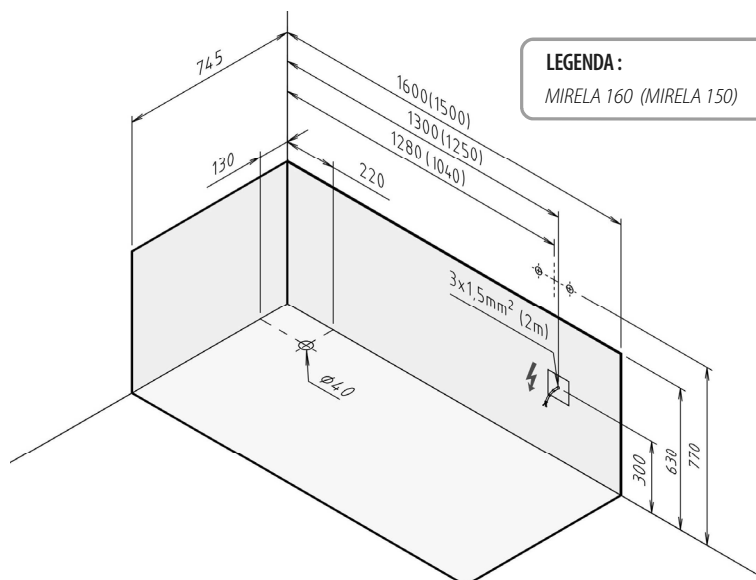
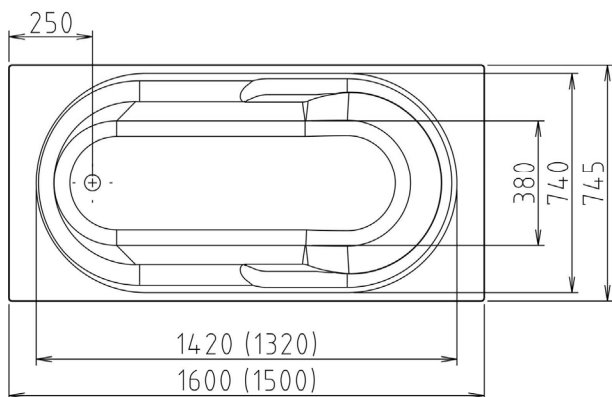

**LEGENDA :**  
MIRELA 160 (MIRELA 150)

## Whirlpool LINE

### MIDI PLUS



### TURBOAIR

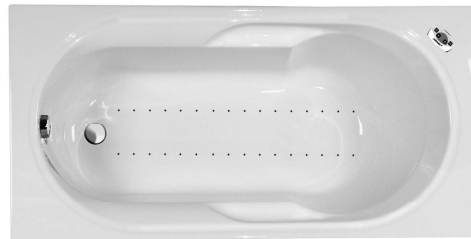

### TURBOAIR KOMBI



### MAXIMUM



V	Hz	Midi plus	Turboair	Turboair kombi	Maximum
220-230	50	1,2 kW	1 kW	2 kW	2,2 kW