



Installation Instruction

MODEL NO.: AU279

Notice: Please read all of the operating instructions before using the product for the first time

If you do not have the expertise required for the installation, do not install it by yourself but ask a qualified technician.

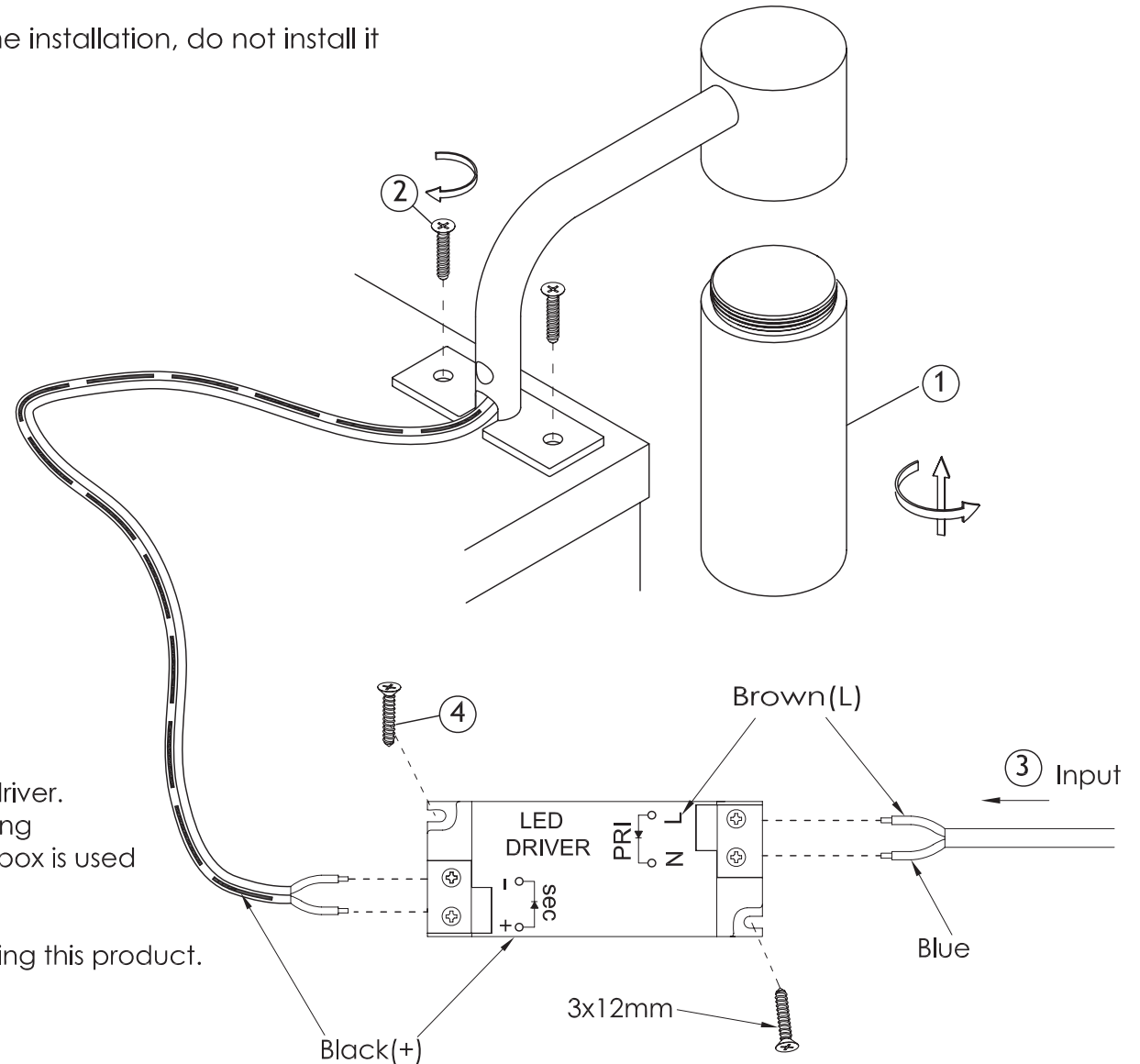
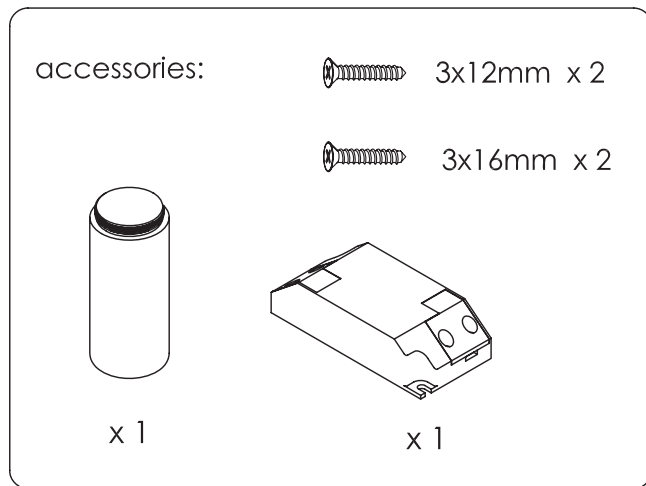

Important Safety Notes

- DO NOT connect these lights directly to the mains.
- ONLY use these lights with a constant current 700mA driver.
- SWITCH OFF electricity at the mains before commencing installation OR undertaking a lamp change. If a fuse box is used ensure that the appropriate circuit fuse is removed to avoid an accidental switching-on of the mains.
- Ensure fire regulations are NOT BREACHED when installing this product.
- DO NOT earth this product.
- These lights are for indoor use only.